

Stamp-S3Bat DIP

SKU:S015-DIP

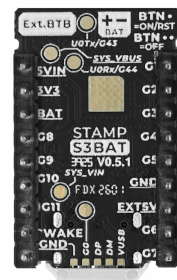

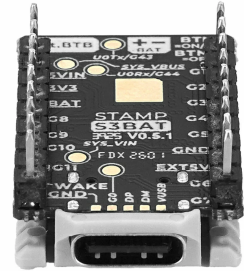
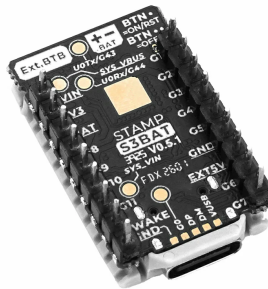
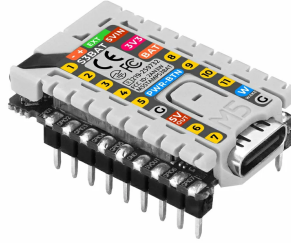
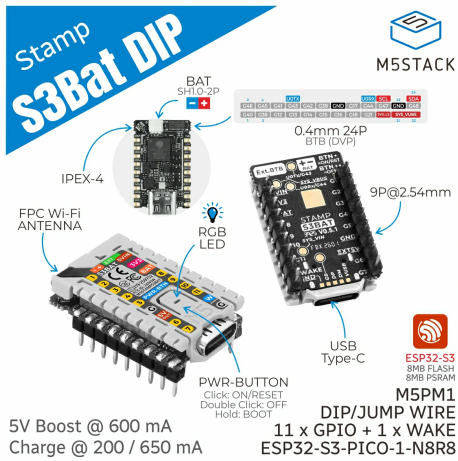
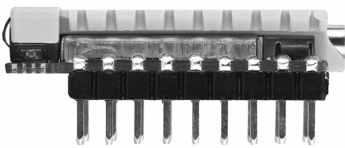
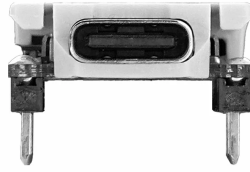
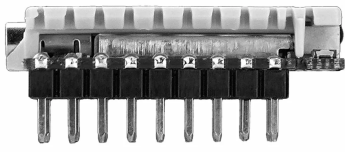

Description

Stamp-S3Bat DIP is an embedded core module with integrated power management. It features the ESP32-S3-PICO-1-N8R8 main controller, supporting 2.4GHz Wi-Fi with built-in 8MB Flash and 8MB PSRAM. The module leads out 11 GPIOs and 1 wake-up IO, equipped with a 24P BTB connector (supporting DVP interface). An onboard battery power interface is provided for connecting an external 3.7V lithium battery. It integrates the M5MP1 multi-stage power control design, supporting power input/output control, lithium battery charging control, and status detection for input voltage and battery voltage. It also supports external low-power wake-up; after the main controller enters low-power sleep mode, the power can be woken up via the external wake-up IO. Featuring a programmable RGB LED, the Stamp-S3Bat DIP version comes with pre-soldered 2.54mm standard pitch headers, allowing integration into applications via PCB insertion, breadboard connection, or Dupont cables to help developers quickly build IoT applications.

Tutorial



Arduino IDE

This tutorial introduces how to program and control the Stamp-S3Bat DIP using Arduino IDE.

Features

- Integrated ESP32-S3-PICO-1-N8R8 controller

- 8MB Flash and 8MB PSRAM
- 24P BTB connector (supporting DVP interface)
- M5PM1 low-power power management
- 11 x GPIO leads + 1x Wake-up IO
- 1x RGB LED
- Power Supply:
 - 3.7V Battery power
 - USB Type-C / DC 5V
- 2.54mm standard pitch headers

| Includes

- 1 x Stamp-S3Bat DIP
- 1 x SH1.0 battery connection cable

| Applications

- IoT project development

| Specifications

Specification	Parameter
SoC	ESP32-S3-PICO-1-N8R8 @ Dual-core Xtensa LX7 processor, frequency up to 240MHz
Flash	8MB
PSRAM	8MB
Wi-Fi	2.4 GHz Wi-Fi
Input Power	3.7V Battery / USB Type-C / DC 5V
RGB LED	1x WS2812
Battery Interface	SH1.0
Pad GPIO Leads	11x GPIO (G1/G2/G3/G4/G5/G6/G7/G8/G9/G10/G11) + 1x Wake-up IO (PY_G4_WAKE)
BTB Interface GPIO Leads	19x GPIO (G40/G38/G12/G13/G14/G15/G16/G18/G21/G46/G45/G41/G43/G42/G39/G17/G44/G47/G48)
BTB Socket	BTB0.408-24PLBDR-M41, 12*2P-FPC Direct Insertion - Black, 0.4mm pitch
Antenna Socket	IPEX-4
Battery Connector	SH1.0-2P
Antenna Type	FPC Antenna
Operating Temp	0 ~ 40°C
Power Consumption	<p>Sleep Mode: 4.2V@13.43uA</p> <p>Standby Mode: 4.2V@955.36uA</p> <p>Light Load Mode: 4.2V@26.83mA</p> <p>Full Load Mode: 4.2V@27.49mA</p>
Product Size	29.8 x 18.0 x 12.0mm
Product Weight	4.5g
Package Size	44.0 x 32.5 x 17.0mm
Gross Weight	9.4g

Learn

Download Mode

Connect the device to the computer via a USB cable, press and hold the **PWR** button for about 3s to enter download mode and wait for burning.

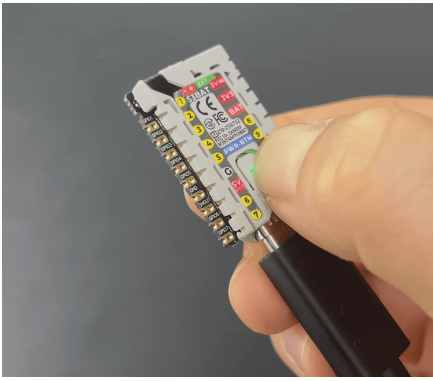

Power On/Off Operation

- Click the **PWR** button to power on / reset:

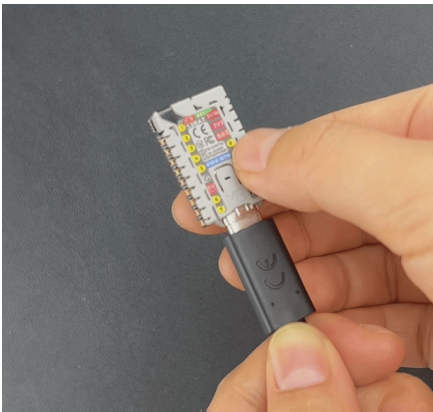

- Double-click the **PWR** button to power off:

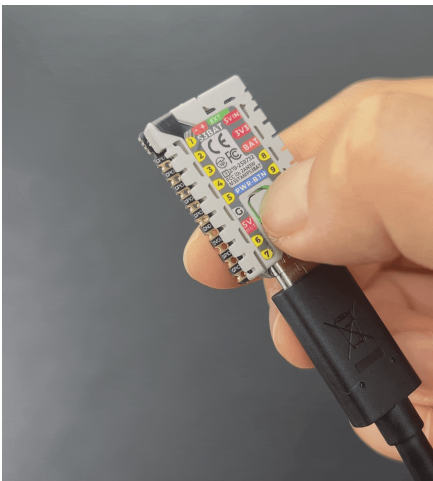

Housing Disassembly

Note

Before welding or SMT, the housing and Wi-Fi antenna must be disassembled first, otherwise, the antenna or housing may be damaged. Please refer to the disassembly tutorial video below for specific operations.

[Stamp-S3Bat-Housing-Disassembly-Tutorial.mp4](#)

Power Supply

The module supports the following three power supply methods. Note that if powered through the 3V3 interface, the module's EXT_5V will not be able to output normally.

- 3.7V lithium battery power supply
- USB Type-C power supply
- DC 5V power supply

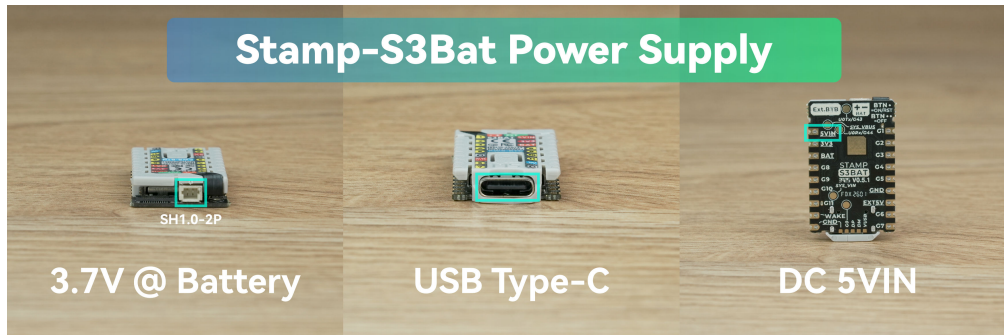

Schematics

- [Stamp-S3Bat DIP Schematics PDF](#)

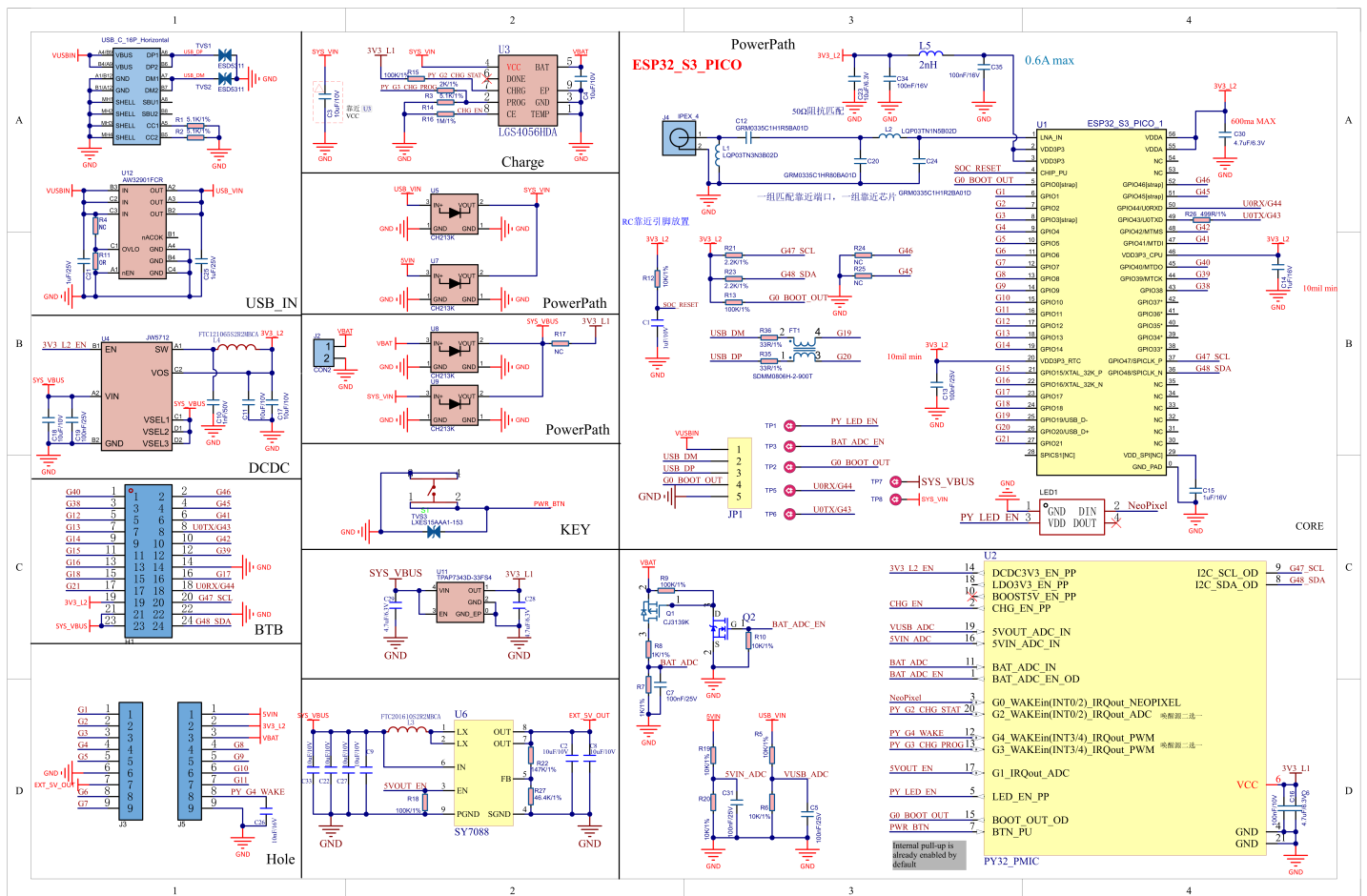

PinMap

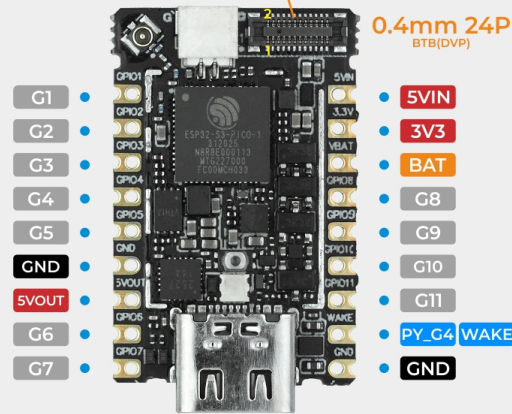

STAMP S3Bat



ESP32-S3	G47	G48
M5PM1(0x6E)	SCL	SDA

M5PM1

M5PM1	G0	G1	G2	G3	G4	PY_LED_PP	CHG_EN_PP
RGB LED	NeoPixel					PY_LED_EN	
Charge			PY_G2_CHG_STAT	PY_G3_CHG_PROG			CHG_EN
5VOUT		5VOUT_EN					
Ext Wakeup					PY_G4_WAKE		

o Switch charging IC current via PY_G3_CHG_PROG (Low: 650mA / Floating: 200mA)

BTB

PIN	LEFT	RIGHT	PIN
G40	1	2	G46
G38	3	4	G45
G12	5	6	G41
G13	7	8	U0TX / G43
G14	9	10	G42
G15	11	12	G39
G16	13	14	GND
G18	15	16	G17
G21	17	18	U0RX / G44
3V3_L2	19	20	SCL
SYS_VBUS	21	22	GND
SYS_VBUS	23	24	SDA

| Model Size

- [Stamp-S3Bat DIP Model Size PDF](#)

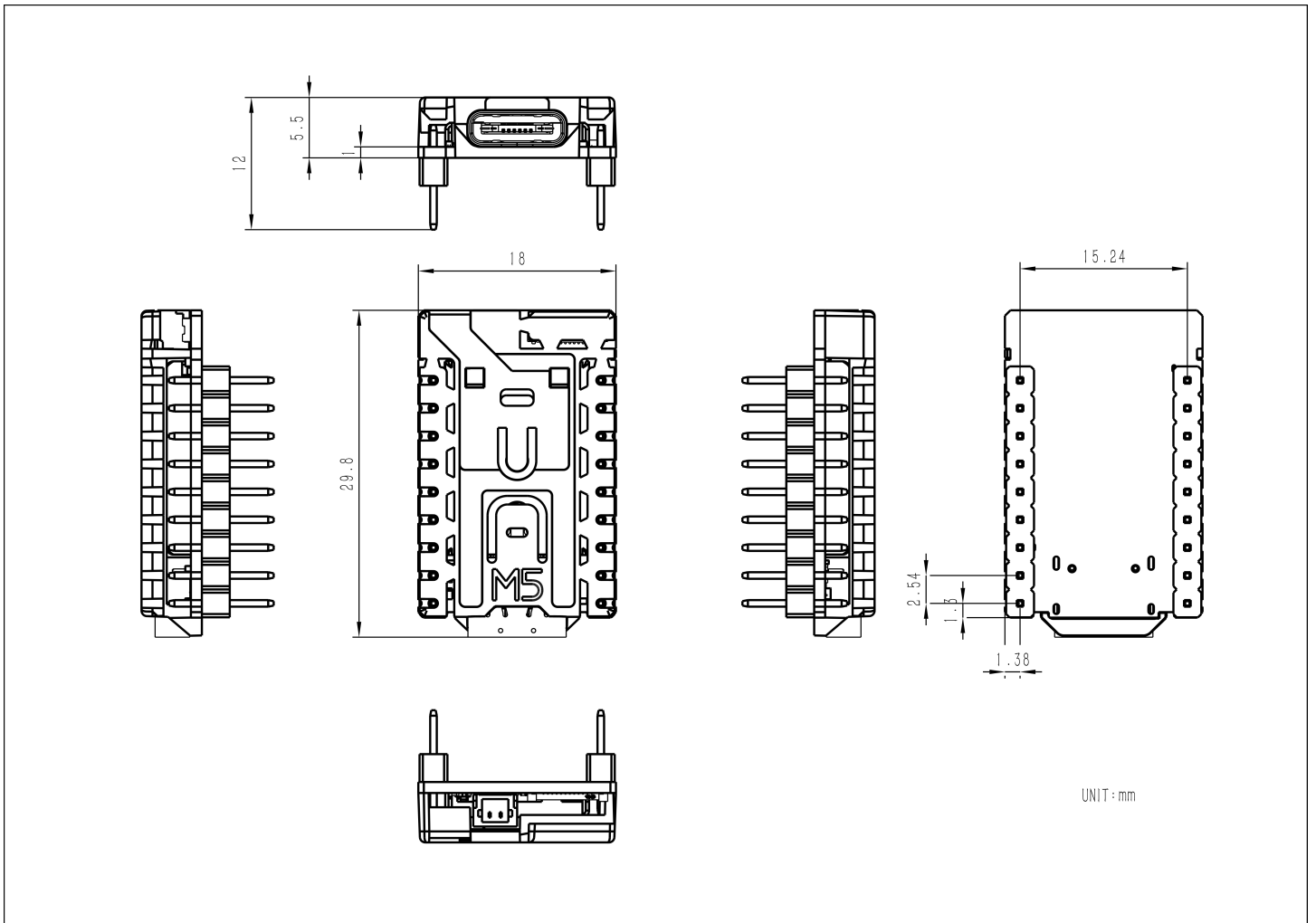

PCB

- [Stamp-S3Bat DIP PcbDoc](#)
- [Stamp-S3Bat DIP KiCad Footprint Library](#)

Datasheets

- [ESP32-S3](#)
- [LGS4056HDA](#)
- [BTB0.408-24PLBDR-M41](#)

Softwares

Arduino

- [Stamp-S3Bat Arduino Quick Start](#)
- [Stamp-S3Bat M5PM1 Power Management](#)
- [M5PM1 Arduino Library](#)

Protocol

- [M5PM1 Power Management Chip](#)

Product Comparison

Product Compare



Stamp-S3Bat DIP



Stamp-S3Bat

Whether the pin header is soldered

Yes

No

If you need to compare the product information of the Stamp series, you can visit the [Product Selection Table](#), and check the target products to get the comparison results. The selection table covers key information such as core parameters and functional features, and supports synchronous comparison of multiple products.

Video

- [Stamp-S3Bat / Stamp-S3Bat DIP Product Introduction and Functional Demonstration](#)

[S015_and_S015-DIP_product_video_EN.mp4](#)